	TANZANIA CIVIL AVIATION AUTHORITY SAFETY REGULATION AERODROMES AND GROUND AIDS	Revision: 0
Document No. TCAA/QSP/SR/AC/AGA-021	ADVISORY CIRCULAR ON CALCULATION OF DECLARED DISTANCES	Page 1 of 6

1. PURPOSE

This Advisory circular (AC) provides guidance to operators to calculate declared distances at aerodrome for safe use of runway and promulgation of aeronautical data to the aeronautical information service.

2. REFERENCE

- 2.1 Manual of Aerodrome Standards, 4th edition, December 2016
- 2.3 Tanzania Civil Aviation (Aerodromes) Regulations, 2017

3.0 INTRODUCTION

Declared distances for an aerodrome runway constitute the relevant distances for the application of the weight and performance requirements in respect of aircraft flying for the purpose of Public Transport. Declaration of these data is essential for safe landing and takeoff of aircraft.

4.0 CALCULATING DECLARED DISTANCES

Declared Distances to be calculated are;

- Take Off Run Available (**TORA**): This is the length of runway available and suitable for the ground run of an aircraft Taking Off.
- Accelerate Stop Distance Available (**ASDA**): This is the length of the TORA plus the length of any associated Stopway if provided.
- Take Off Distance Available (**TODA**): This is the length of the TORA plus the length of any associated Clearway if provided.
- Landing Distance available (**LDA**): This is the length of the runway available and suitable for the ground landing run of an aeroplane.

This is a controlled document	Issued February 2017
-------------------------------	----------------------

	<p style="text-align: center;">TANZANIA CIVIL AVIATION AUTHORITY SAFETY REGULATION</p> <p style="text-align: center;">AERODROMES AND GROUND AIDS</p>	<p style="text-align: right;">Revision: 0</p>
<p>Document No. TCAA/QSP/SR/AC/AGA-021</p>	<p style="text-align: center;">ADVISORY CIRCULAR ON CALCULATION OF DECLARED DISTANCES</p>	<p style="text-align: right;">Page 2 of 6</p>

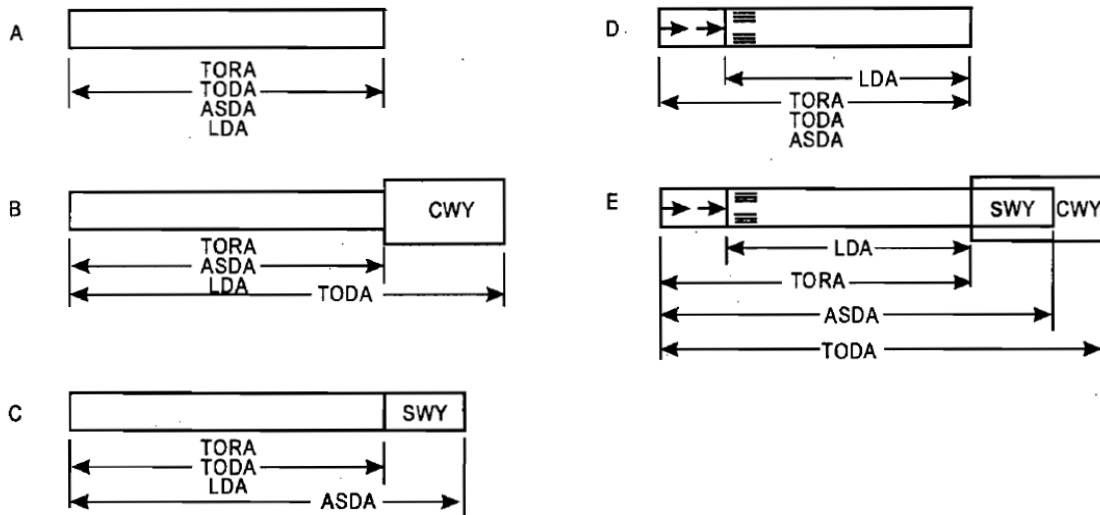



Figure 1

The TORA, ASDA ,TODA and LDA should be measured for each paved and unpaved runway. For this purpose, unpaved runways are to be marked as indicated in Advisory Circular No. **TCAA/QSP/SR/AC/AGA-14**. The distances are measured along the centerline of the runway and of any associated stopway and clearway, and should be declared by publication in the AIP or in a NOTAM.

Declared distances may be increased after prior assessment and approval of the Director of Safety Regulation of the Tanzania Civil Aviation Authority.

The intended use of a runway or part thereof for takeoff or for landing, using either visual or instrument approach procedures, will determine the criteria to be applied in measuring the distance which may be declared. Alternatively the ability to meet the criteria will decide what length of runway may be declared for what purpose. For example, a

	<p style="text-align: center;">TANZANIA CIVIL AVIATION AUTHORITY SAFETY REGULATION</p> <p style="text-align: center;">AERODROMES AND GROUND AIDS</p>	<p>Revision: 0</p>
<p>Document No. TCAA/QSP/SR/AC/AGA-021</p>	<p>ADVISORY CIRCULAR ON CALCULATION OF DECLARED DISTANCES</p>	<p>Page 3 of 6</p>

runway strip should extend beyond the end of a runway or stopway where the code number is 2, 3 or 4, or where the code number is 1 and the runway is an instrument one, for a distance of 60 metres. A strip including a precision approach runway as well as a non precision approach runway shall extend laterally to a distance of at least 150 metres on each side of the runway centre line and its extended centre line through the length of the strip where the code number is 3 or 4. However, such a runway should also have a Runway End Safety Area (**RESA**) extending beyond the end of the strip for at least 90 metres at a minimum width of twice that of the associated runway. It is however, recommended that as far as practicable, the RESA should extend from the end of the runway strip to a distance of 240 metres where the code number is 3 or 4. The end of the declared TORA, ASDA and LDA should be adjusted so that the Runway End Safety Area (RESA) is provided as well as the required strip length and width. If the particular runway is served by an instrument approach procedure, the strip width to be applied when determining LDA will differ from that required for TORA and ASDA.

5.0 DISPLACEMENT OF THRESHOLD

The threshold is the start of that part of a runway that is declared as available for landing. When the individual requirements for strip width and length, and runway end safety area are met, the threshold will normally be located at the start of the runway. However, it may be necessary to account for any of those physical characteristics or an obstacle that cannot be removed and extends above the approach surface by displacement of the threshold from the runway end as indicated in the Manual of Aerodrome Standards (Doc No. TCAA/QSP/MOS/AGA-01) .The amount by which the threshold is displaced will vary with the individual circumstances of each situation, regards being given to;

- The nature and type of traffic;
- Whether the runway is an instrument runway or a visual runway, and if it is an instrument runway whether it is a precision approach runway or non precision approach runway;
- The position of any obstacle that either affects the RESA or infringes the approach surface, in relation to the threshold and extended centerline of the runway;
- The amount by which the obstacle penetrates the approach surface and its significance in the calculation of the obstacle clearance height;

This is a controlled document	Issued February 2017
-------------------------------	----------------------

	<p>TANZANIA CIVIL AVIATION AUTHORITY SAFETY REGULATION</p> <p>AERODROMES AND GROUND AIDS</p>	<p>Revision: 0</p>
<p>Document No. TCAA/QSP/SR/AC/AGA-021</p>	<p>ADVISORY CIRCULAR ON CALCULATION OF DECLARED DISTANCES</p>	<p>Page 4 of 6</p>

- The angle of the glide path or nominal glide path for an instrument approach procedure and the calculated obstacle clearance height;
- The limited visibility and cloud base conditions under which the runway will be used.

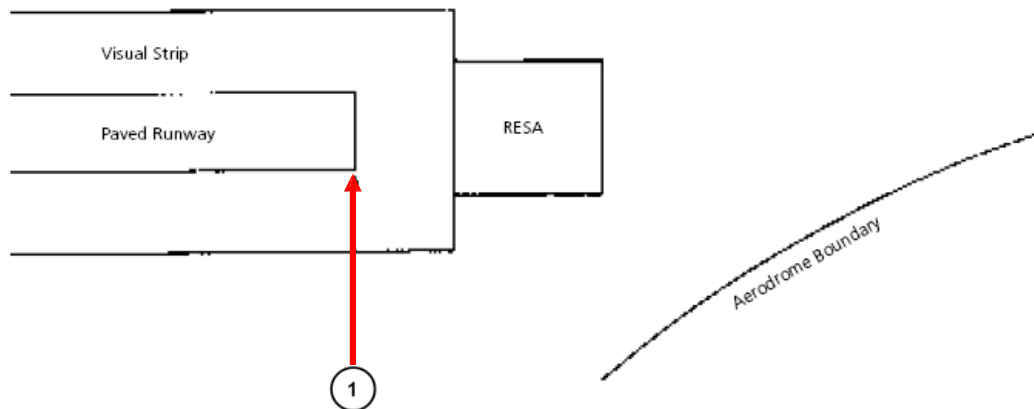



Figure 2

1 - (illustrated above) would be the end of TORA and ASDA (no stopway), and the end of LDA for a visual runway. It would be the start of TORA, ASDA and TODA in the reciprocal direction, and also LDA unless the threshold was displaced because of obstacles in the approach area

	<p style="text-align: center;">TANZANIA CIVIL AVIATION AUTHORITY SAFETY REGULATION</p> <p style="text-align: center;">AERODROMES AND GROUND AIDS</p>	<p style="text-align: right;">Revision: 0</p>
<p>Document No. TCAA/QSP/SR/AC/AGA-021</p>	<p style="text-align: center;">ADVISORY CIRCULAR ON CALCULATION OF DECLARED DISTANCES</p>	<p style="text-align: right;">Page 5 of 6</p>

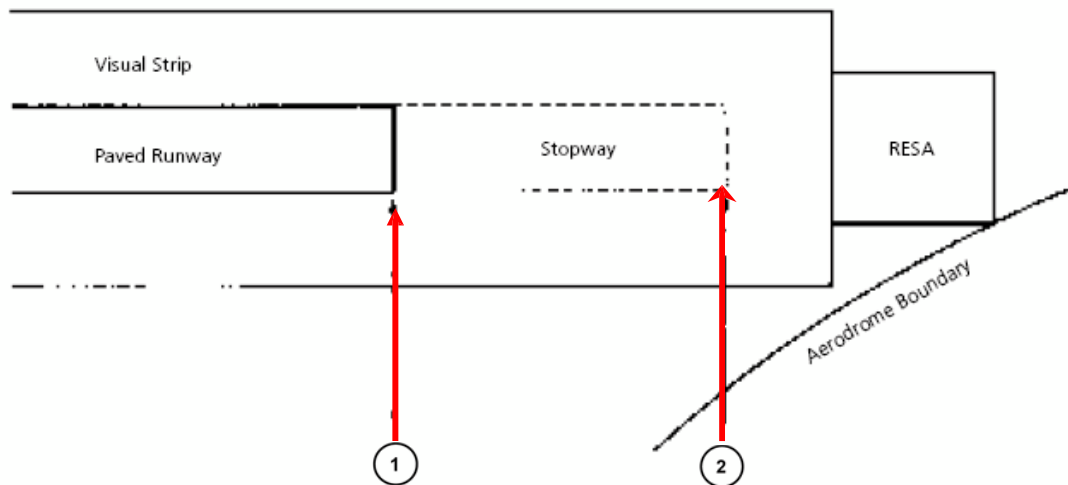



Figure 3

Here the runway depicted in Fig 3 has been supplemented by the provision of stopway.

1 - (illustrated above) would be the end of TORA and LDA for a visual runway. It would be the start of TORA, ASDA and TODA in the reciprocal direction, and also the start of LDA unless the threshold was displaced because of obstacles in the approach area.

2 - (illustrated above) would be the end of ASDA, limited by the RESA short of the aerodrome boundary not by the strip width

	TANZANIA CIVIL AVIATION AUTHORITY SAFETY REGULATION AERODROMES AND GROUND AIDS	Revision: 0
Document No. TCAA/QSP/SR/AC/AGA-021	ADVISORY CIRCULAR ON CALCULATION OF DECLARED DISTANCES	Page 6 of 6

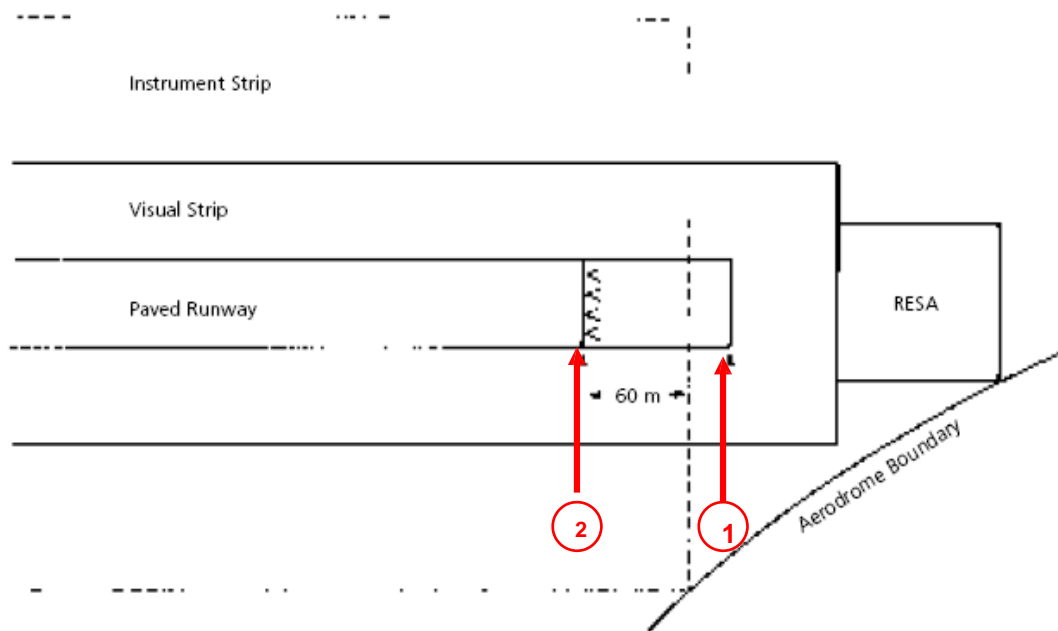

The runway at Figure 2 and 3 has been extended by paving the declared stopway of Figure 3 to full runway strength.

1 - (illustrated above) would be the end of TORA and LDA for a visual runway. It would be the start of TORA, ASDA and TODA in the reciprocal direction, also LDA unless the threshold was displaced because of obstacles in the approach area.

2 - (illustrated above) would be the end of LDA for an instrument runway, the provision of the required instrument strip becoming the limiting factor, and the start of LDA in the reciprocal direction, subject to the availability of an acceptable obstacle free approach surface.

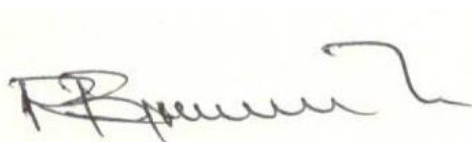

Tanzania Civil Aviation Authority